

# PROPELLER GUIDE





## A PERFECT MATCH

A correct choice of propeller is absolutely vital to get the most out of your engine and boat. Their performance decides whether the power produced by your engine and drive is turned into boat performance – or not. And it's not only size and pitch that matters.

Genuine Volvo Penta propellers are designed for their specific task. The wide range covers propellers for shaft installations, single-propeller drives, Duoprop drives and saildrives as well as for the revolutionary IPS.

Production quality is exceptional with minimized tolerances, ensuring high and reliable performance, year after year. Volvo Penta propellers are perfectly matched to engine characteristics and drive hydrodynamics. This gives you the best overall efficiency, which benefits you – and the environment – as you reduce fuel consumption. It also gives your engine and drive a long service life, as they work with the load they've been designed for.

### **MPS tool**

For correct analysis and prediction of boat related information such as propeller options, top speed, shaft dimensions, etc. Please refer to Volvo Penta Marine Propulsion Software at "[vppn.volvo.com](http://vppn.volvo.com)". The MPS tool is intended for the Volvo Penta organisation, our boat builders and dealers. The MPS tool is free to use.



# CONTENT

Developed by Volvo Penta	4
Propeller anatomy	5
Duoprop technology	7

## PROPELLERS FOR AQUAMATIC

Duoprop for DP280, 290 drives	
Type A	8
Type B	9
Type C	9
Duoprop for the DPX drive – Type E	9
Single propellers for the 200-290 drives	10
Duoprop for the DPS drive – Type D	13
Duoprop for the DPS drive – Type F	13
Duoprop for the DPS drive – Type I	13
Single propellers for the SX-drive	14
Duoprop for the DPH drive – Type G	15
Duoprop for the DPR drive – Type GR	15

## PROPELLERS FOR VOLVO PENTA IPS

Type T	17
Type P	17
Type Q	17

## PROPELLERS FOR SAILBOATS

Volvo Penta folding propellers	18
2-blade folding propeller	19
3-blade folding propeller	20
4-blade folding propeller	21
Fixed propellers for S-drive	22



## DEVELOPED BY VOLVO PENTA

Developing a new propeller takes over one year of computer calculations to ensure the props are equally efficient at any speed and under any load. Cavitation tunnel test, real-life close-up studies of prototypes and boat testing. All this, to determine that the feel is perfect and what performance they give. We continuously develop the entire package; engine, drive and propellers.

### SUPER-STRENGTH MATERIAL

The different materials used are all super-strength and crafted for propeller duty. This gives a certain built-in flexibility. The material handles the forces without bending or breaking.

### THE EFFICIENCY

A combination of curving, blade surface and cavitation design. Only when all these factors are perfect do you get maximum efficiency.

### THE BALANCE

Each propeller is perfectly in balance, in weight, size and cavitation. Essential for secure grip in curves and driving safety.

### THE BUSHINGS

Much more than a piece of rubber! Each propeller has its bushing specifically adapted to handle turning and pulling forces. The bushing gets its final shape and performance when the correct fastening torque is applied. Essential for smooth shifting and long drive-train lifetime.

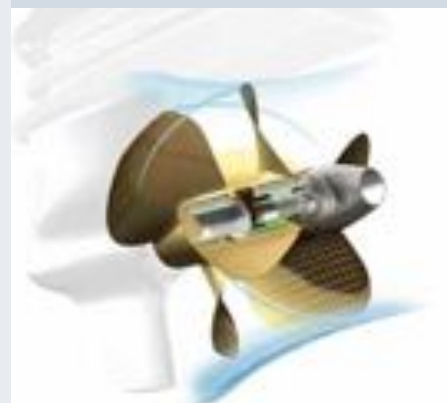

# PROPELLER ANATOMY

## 3 OR 4 BLADES

A 3-blade propeller usually offers top speed performance while a 4-blade propeller provides maximum thrust and smooth cruising operation.



## PITCH

Pitch is the theoretical distance a propeller will move through the water for each revolution (i.e. a 21" pitch propeller should move a boat forward 21" for each revolution, assuming there is no slippage).

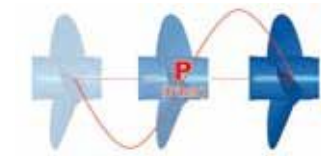

## CUPPED BLADES

This is a technique used to enhance the performance of propellers under certain conditions; a cupped propeller will exhibit very high efficiency at high speeds as well as minimize cavitation under heavy loads.

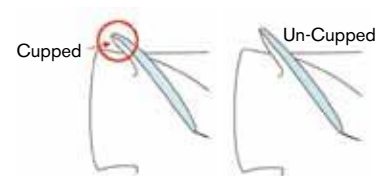

## DIAMETER

Diameter is the distance across a circle encompassing all of the propeller blades. Measure from the centre of the propeller hub to the tip of the blades and multiply this by two.



## RIGHT HAND OR LEFT HAND ROTATION

In most cases, right hand propellers are used for single engine applications and one right hand and one left hand propellers are used for twin engine applications to achieve better steering control.

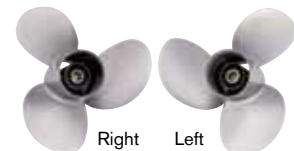

## RAKE

Rake is a special design feature. Positive rake benefits from normal bow lift to permit the use of a larger diameter propeller, while negative rake can provide extra blade strength for use in very high speed applications.

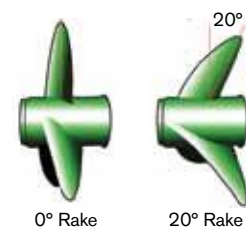

## W.O.T.

Wide open throttle. With the boat fully loaded the boat should run within 200RPM's of the maximum rated RPM of the engine.

## RPM:

Revolutions per minute. Prop size differences have a big impact on boat performance. For example:

- If at W.O.T. the RPM is too high, you will need to try a prop with a higher pitch or higher diameter.
- If at W.O.T. the RPM is too low, you will need to try a prop with a lower pitch or a lower diameter.





## VOLVO PENTA DUOPROP – TECHNOLOGY WITH A GRIP

Nothing bites into the water as efficient as Duoprop. It was introduced by Volvo Penta in 1982 – the biggest event in boating since the Volvo Penta aquamatic drive was introduced. The principle behind Duoprop is simple: The counter rotating twin propellers eliminate the lateral forces existing in conventional single propeller stern drives. Consequently the engine's energy and power is concentrated on driving the boat forward – not sideways. This results in several benefits for your boating pleasure.

### **FASTER ACCELERATION, LOWER FUEL CONSUMPTION**

Duoprop provides up to 30% faster acceleration and produces a top speed 5% faster than any conventional single propeller system – without increasing fuel consumption. With a partial load, you can expect between 10 and 12 % lower fuel consumption.

### **FASTER PLANING**

A better grip in the water means getting up and onto the plane faster. And staying there at lower revs.

### **MANOEUVRABILITY IS BETTER TOO**

Whether at high speeds, making sharp turns, or when docking in a crowded marina – the grip is there. Duoprop also reduces the boat's tendency to roll.

### **LOWER VIBRATION AND NOISE LEVELS**

Duoprop produces lower vibration and noise levels due to the fact that shock pulses are distributed over more blades. With its counter-rotating propellers, it is almost cavitation free.

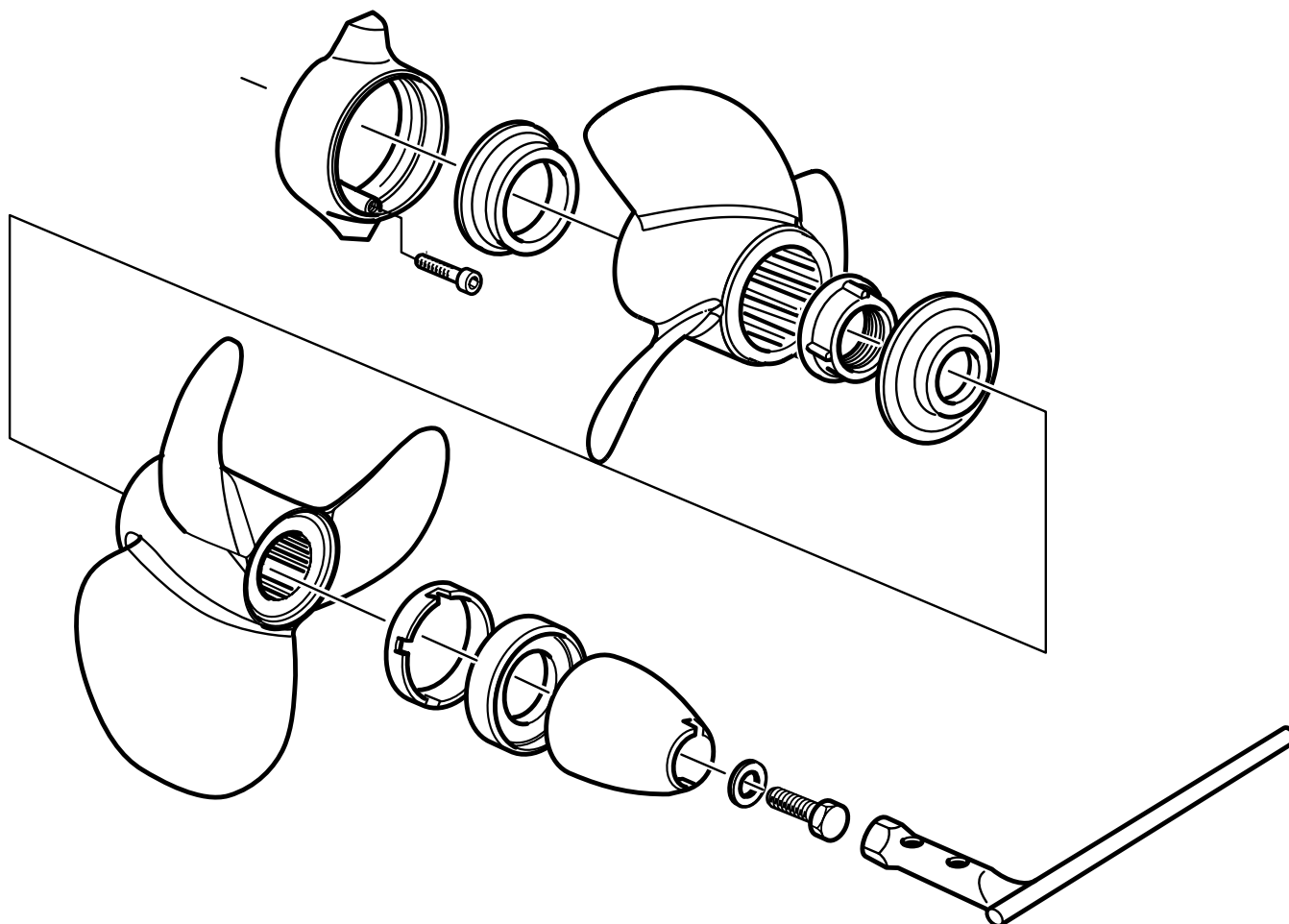





## DUOPROP FOR DP280, 290 DRIVES – TYPE A

Aluminium DP propeller for diesel engines. The unique design, of the 3-blade propeller in the front and the 4-blade propeller behind, is the key to the outstanding grip in the water.

**Note!** Not for KAD42-44 and KAD300

Propeller cone: shaft 20 mm – 872549.  
shaft 16 mm – 872614.

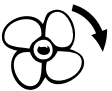

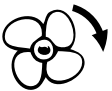
DIM				DIM			
A 0	872270	872259	872264	A 6	854769	854779	854789
A 1	854764	854774	854784	A 7	854770	854780	854790
A 2	854765	854775	854785	A 8	854771	854781	854791
A 3	854766	854776	854786	A 9	854772	854782	854792
A 4	854767	854777	854787	A 10	854773	854783	854793
A 5	854768	854778	854788				





## DUOPROP FOR DP280, 290 DRIVES – TYPE B

Aluminium DP propeller for gasoline and diesel engines. For speeds above 35 knots we recommend the stainless Type C propeller. The two 3-blade propellers have very thin blade profiles, demanding the highest level of precision.

Propeller cone: shaft 20 mm – 872549.  
shaft 16 mm – 872614.

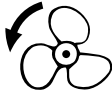
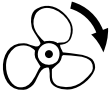

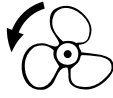
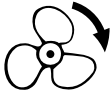

DIM				DIM			
B 1	854814	854822	854830	B 5	854818	854826	854834
B 2	854815	854823	854831	B 6	854819	854827	854835
B 3	854816	854824	854832	B 7	854820	854828	854836
B 4	854817	854825	854833	B 8	854821	854829	854837

## DUOPROP FOR DP280, 290 DRIVES – TYPE C

The Volvo Penta state-of-the-art stainless steel DP propeller has been specially designed to give maximum thrust where most needed. The high speed is achieved through thinner blades and powerful thrust. Greater torsional strength adds faster acceleration. The stainless steel material makes the propellers durable and highly resistant to cavitation, damage and corrosion. All these factors contribute to excellent handling and comfort.

Propeller cone: shaft 20 mm – 872549.  
shaft 16 mm – 872614.

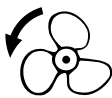
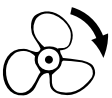

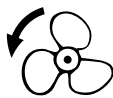
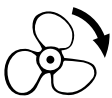
DIM				DIM			
C 2	3860877	3860602	3860603	C 5	3857496	3857462	3857466
C 3	3860878	3860604	3860605	C 6	3857497	3857463	3857467
C 4	3857495	3857461	3857465	C 7	3857498	3857464	3857468

## ACCESSORIES FOR DP280-290 TYPE A, B, C

Part No	Qty	Description
3851334	1	Propeller nut
876138	1	Anode kit
3858458	1	Thrust ring



Part No	Qty	Description
3858457	1	Thrust ring
875821	1	Zinc ring kit
873058	1	Tool kit

Part No	Qty	Description
828250	1	Lubricating grease 25g
21347121	1	Grease, prop shaft 400ml
3809449	1	Grease 500g

## DUOPROP FOR THE DPX DRIVE – TYPE E

The stainless steel DP-E propeller is specially developed to handle the high forces of the DPX high speed drive. Handling speeds up to 75 knots put high demands on the propellers performance.

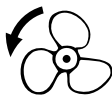

DIM			
E 2	3860065	872422	3860011
E 3	3860066	872423	3860012
E 4	3860067	872424	3860013

## ACCESSORIES THE DPX DRIVE – TYPE E

Part No	Qty	Description
3851335	1	Propeller nut
872179	1	Propeller nut
872546	1	Lock screw

Part No	Qty	Description
885195	1	Tool kit

Part No	Qty	Description
828250	1	Lubricating grease 25g
21347121	1	Grease, prop shaft 400ml
3809449	1	Grease 500g

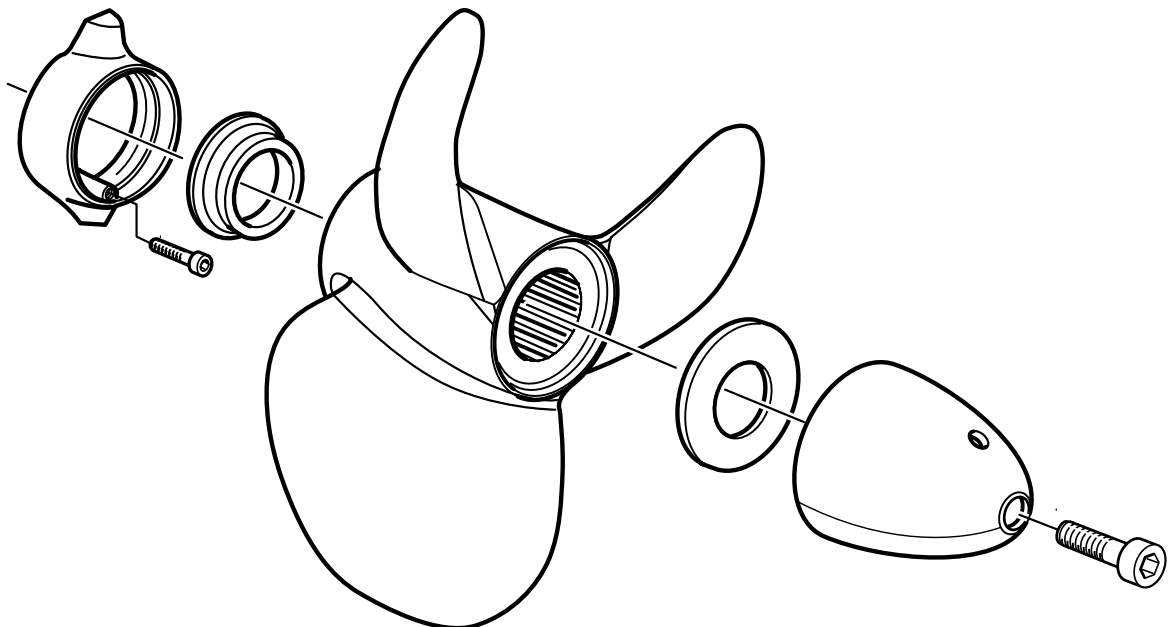
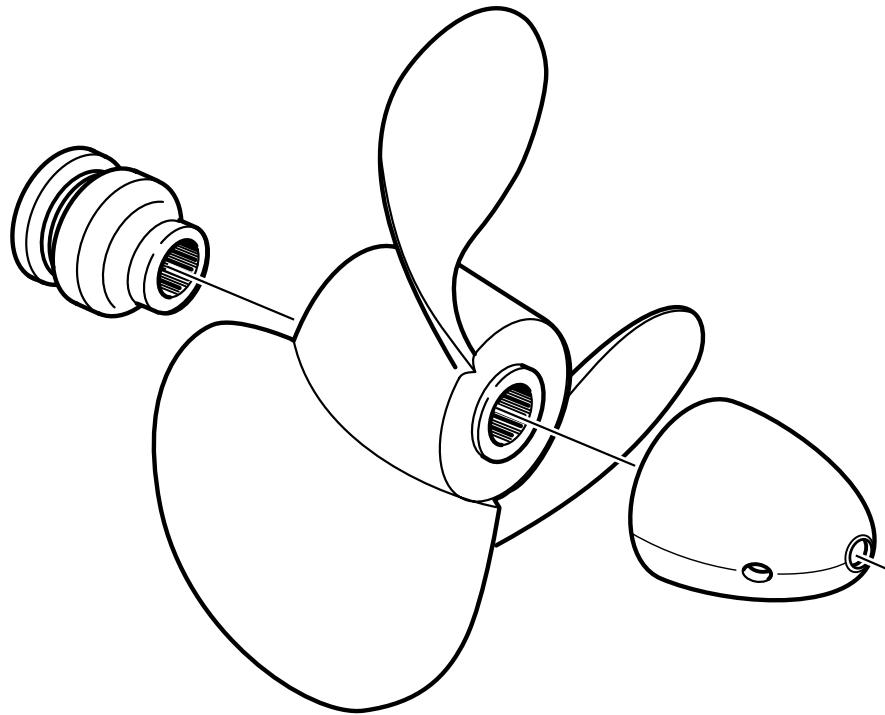

## SINGLE PROPELLER FOR THE 200-290 DRIVES

The increased blade area of the high speed propeller makes it most suitable for use with high power engines and at high revs. In a fast boat this does not only mean increased speed, it also means that a heavily loaded boat will plane more quickly and enjoy better fuel economy. The high speed propeller's excellent reversing characteristics also mean faster and safer quayside manoeuvring.

### ALUMINIUM HIGH SPEED LONG HUB PROPELLER

V6 and V8 engines should always be fitted with the long hub which is also suitable for 4 cylinder petrol engines.

STD = Standard Propeller HS = High Speed propeller

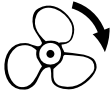
Ø x PITCH		
14 x 17	854977	854992
14 x 19	854978	854993
14 x 21	854979	854994
14 x 23	854980	854995
15 x 15	854981	854996
15 x 17	854982	854997
15 x 19	854983	854998
15 x 21	854984	854999
16 x 9	854985	—
16 x 13	854986	872000
16 x 15	854987	872001
16 x 17	854988	872002
16 x 19	854989	872003
16 x 21	854990	872004
16 x 23	854991	872005



### ALUMINIUM HIGH SPEED AND STANDARD PROPELLER, SHORT HUB

STD = Standard Propeller HS = High Speed propeller

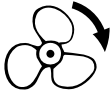
Ø x PITCH		
14 x 13	813284 STD	813285 STD
14 x 15	814626 HS	814631 HS
14 x 17	814627 HS	814632 HS
14 x 19	814628 HS	814633 HS
15 x 11	813296 STD	813297 STD
15 x 13	813316 STD	813317 STD
15 x 15	814611 HS	814615 HS
15 x 17	814612 HS	814616 HS



### STANDARD PROPELLERS FOR 100 DRIVES WITH CYLINDRICAL SHAFT AND LOCKING PIN

STD = Standard Propeller HS = High Speed propeller

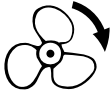
Ø x PITCH		
13 x 13	813224	813233
13 x 15	839186 HS	
14 x 11	813227	
14 x 11	804449 *	
14 x 13	813229	
14 x 15	832992	



### ACCESSORIES SINGLE PROPELLERS

Part No Qty Description

854045 1 Propeller cone

854047 1 Spacer ring

897367 1 Tab washer

Part No Qty Description

850888 1 Thrust washer

850889 1 Screw

873058 1 Tool kit

Part No Qty Description

828250 1 Lubricating grease 25g

21347121 1 Grease, prop shaft 400ml

3809449 1 Grease 500g

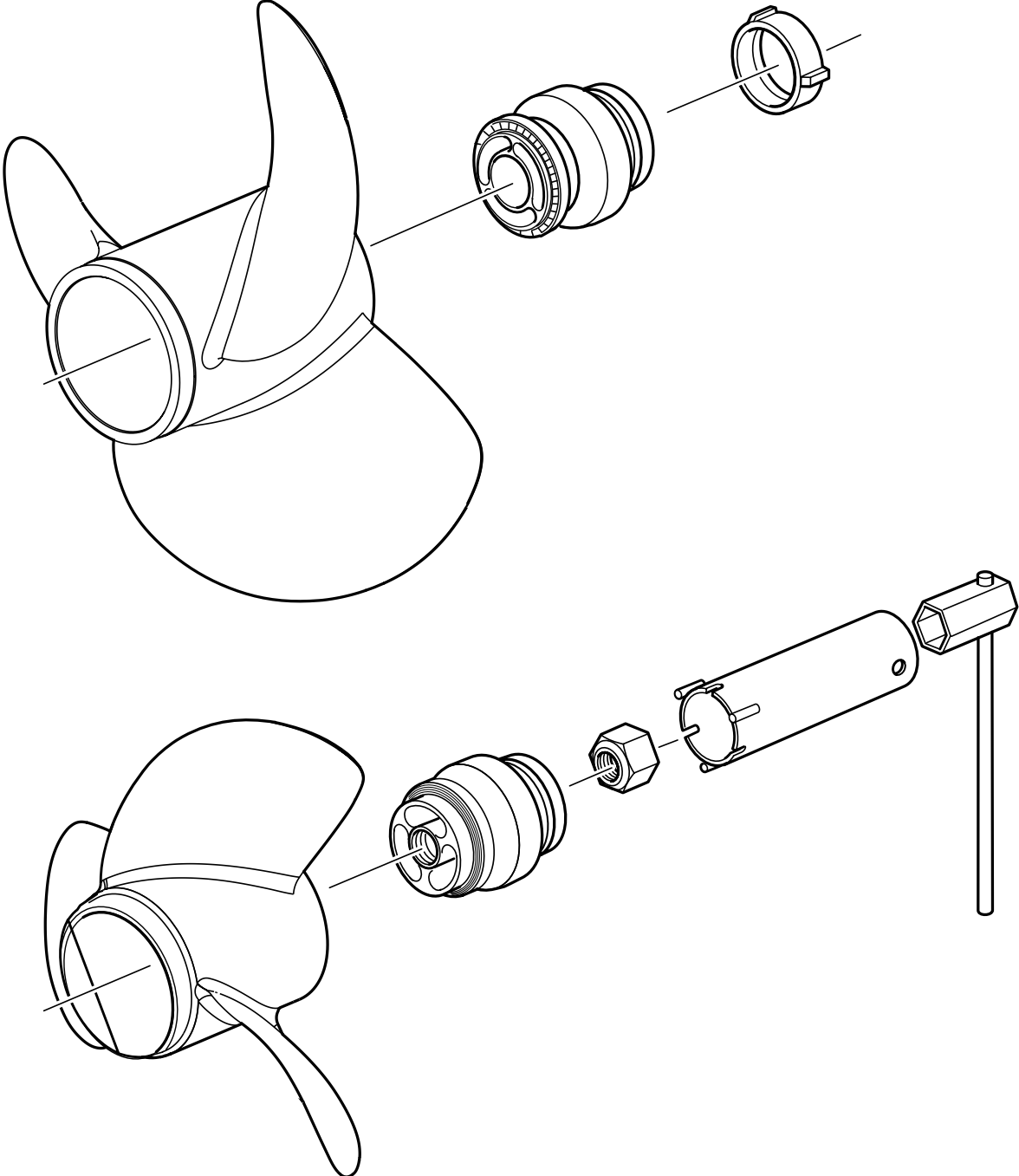



## DUOPROP FOR THE DPS DRIVE – TYPE D

The aluminium propeller for all gasoline and diesel engines using the DPS drive, with speeds up to 35 knots. For complete kit use the I series propellers.

**Note!** Do not mix D series with I series on the same drive. For twin installations use only the same propellers. Do not mix D and I propellers.

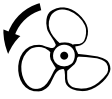
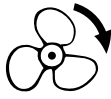

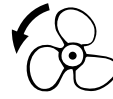
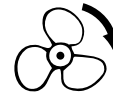



DIM				DIM			
D 0	—	3851420	3851440	D 5	—	3856345	3856355
D 1	—	3851421	3851441	D 6	—	3856346	3856356
D 2	—	3851422	3851442	D 7	—	3856347	3856357
D 3	—	3851423	3851443				

## DUOPROP FOR THE DPS DRIVE – TYPE F

The stainless steel option for high performance gasoline and diesel engines with DPS drive. The material used gives the propeller blades greater torsional strength and is more resistant to cavitation damage.



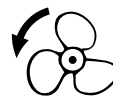
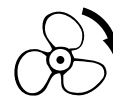





DIM				DIM			
F 2	3857563	3857557	3857558	F 6	3851496	3851466	3851476
F 3	3857564	3857559	3857560	F 7	3851497	3851467	3851477
F 4	3851494	3851464	3851474	F 8	3851498	3851468	3851478
F 5	3851495	3851465	3851475	F 9	3851499	3851469	3851479

## DUOPROP FOR THE DPS DRIVE – TYPE I

The development work and experience from the successful DPH and IPS duo-propellers have been possible to transfer to a new aluminium propeller serie. The new blade geometry with thinner and bigger blades (patented design) gives improved performance regarding: acceleration top speed and propeller grip. Improved corrosion resistance. The aluminium propeller for all gasoline and diesel engines using the DPS drive, with speeds up to 38 knots.

**Note!** Do not mix D series with I series on the same drive. For twin installations use only the same propellers. Do not mix D and I propellers.

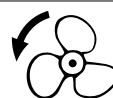

DIM				DIM			
I 2	21258482	21260642	21324312	I 7	21258487	21260647	21324317
I 3	21258483	21260643	21324313	I 8	21258488	21260648	21324318
I 4	21258484	21260644	21324314	I 9	21258489	21260649	21324319
I 5	21258485	21260645	21324315	I 10	21258490	21260650	21324320
I 6	21258486	21260646	21324316				

## ACCESSORIES FOR THE DPS DRIVE – TYPE D, F AND I

Part No	Qty	Description
3851569	1	Propeller nut, front
3851341	1	Propeller nut, rear
3851600	1	Front spacer ring

Part No	Qty	Description
3862797	1	Tool, front
3862808	1	Tool, rear
3855516	1	Tool kit

Part No	Qty	Description
828250	1	Lubricating grease 25g
21347121	1	Grease, prop shaft 400ml
3809449	1	Grease 500g

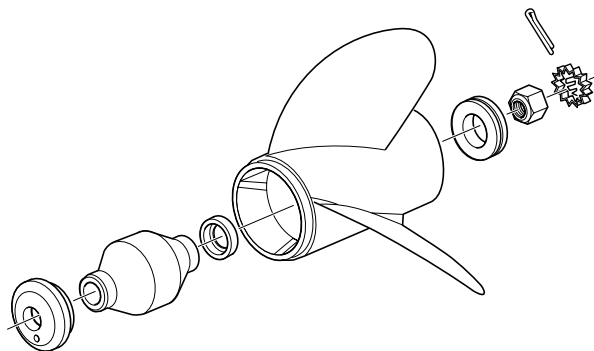

## SINGLE PROPELLERS FOR SX DRIVE

The SX propeller is available in 3-blade aluminium and stainless steel as well as 4-blade aluminium. The 3-blade SX is perfect for the standard installation and the stainless propeller being the perfect choice for high speeds. The 4-blade SX propeller is the perfect choice when acceleration and remaining planing at lower revs are important.

### 3-BLADE

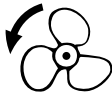
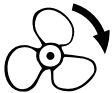

ALUMINIUM Ø x PITCH		
14,3 x 21	-	3817469
14,2 x 23	-	3817470
14,5 x 19	3817473	3817468
14,8 x 17	3817472	3817467
15 x 15	3817471	3817466
15 x 16	-	-
15,5 x 12	3855476	-
15,5 x 13	3855477	3840720
15,5 x 14	3855478	-

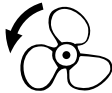
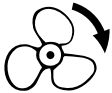

STAINLESS STEEL Ø x PITCH		
14,75 x 17	3860714	3862462
14,75 x 19	3860715	3860708
14,75 x 21	3860716	3860709
14,25 x 23	3860717	3870710

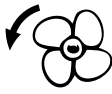

### 4-BLADE

ALUMINIUM Ø x PITCH		
14,75 x 15	3587519	3587517
14,5 x 17	3587521	3587520
14,25 x 19	3587523	3587522
14 x 21	3587525	3587524
14 x 23	3587527	3587526



## ACCESSORIES FOR THE SX DRIVE - ALUMINIUM, STAINLESS STEEL

Part No	Qty	Description
3850984	1	Propeller nut kit
	1	Nut
	1	Retainer
3852350	1	Spacer
3852056	1	Cotter pin



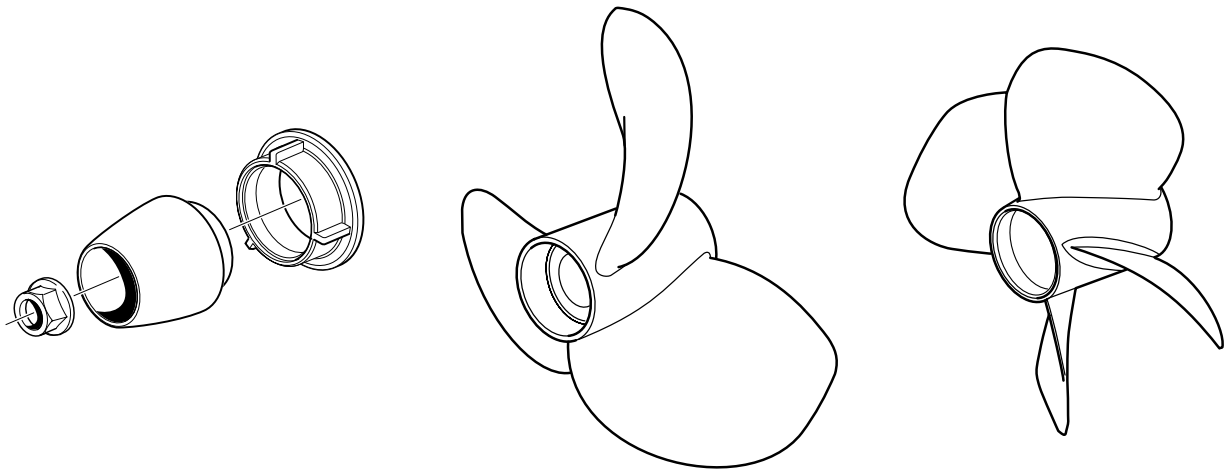



Part No	Qty	Description
3587601	1	Propeller Bushing
828250	1	Lubricating grease 25g
21347121	1	Grease, prop shaft 400ml
3809449	1	Grease 500g

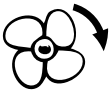

### DUOPROP FOR THE DPH DRIVE - TYPE G

The combination of a 3-blade front and a 4-blade rear propeller, is the key to the tremendous grip in the water. The new generation DP propellers has been specially developed to handle the tremendous torque and power from the D4 and D6 engines. Performance is outstanding and the special nickel-aluminium-bronze alloy complete with full electric isolation ensures no growth and excellent corrosion resistance.

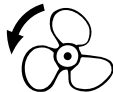

DIM				DIM			
G2	3587375	3587386	3587388	G7	3587382	3587398	3587399
G3	3587378	3587389	3587390	G8	3587383	3587400	3587401
G4	3587379	3587391	3587392	G9	3587384	3587402	3587403
G5	3587380	3587393	3587394	G10	3587385	3587404	3587405
G6	3587381	3587395	3587397				

### ACCESSORIES FOR THE DPH DRIVE - TYPE G



Part No	Qty	Description
3807136	1	Propeller Cone kit (cone, front & rear nut)
3863211	1	Propeller nut, front
3863213	1	Propeller nut, rear
21318669	1	Tool

Part No	Qty	Description
828250	1	Lubricating grease 25g
21347121	1	Grease, prop shaft 400ml
3809449	1	Grease 500g

### DUOPROP FOR THE DPR DRIVE - TYPE GR

The GR propeller is developed to handle the outstanding demand for thrust and strength placed by the new DPR high speed drive developed for the new D4 and D6 engines. Made in stainless steel.



DIM			
GR7	3863492	3863501	3863502
GR8	3863493	3863503	3863504
GR9	3863494	3863505	3863506

### ACCESSORIES FOR THE DPR DRIVE - TYPE GR

Part No	Qty	Description
3863211	1	Propeller nut, front
3863213	1	Propeller nut, rear
21318669	1	Tool

Part No	Qty	Description
828250	1	Lubricating grease 25g
21347121	1	Grease, prop shaft 400ml
3809449	1	Grease 500g

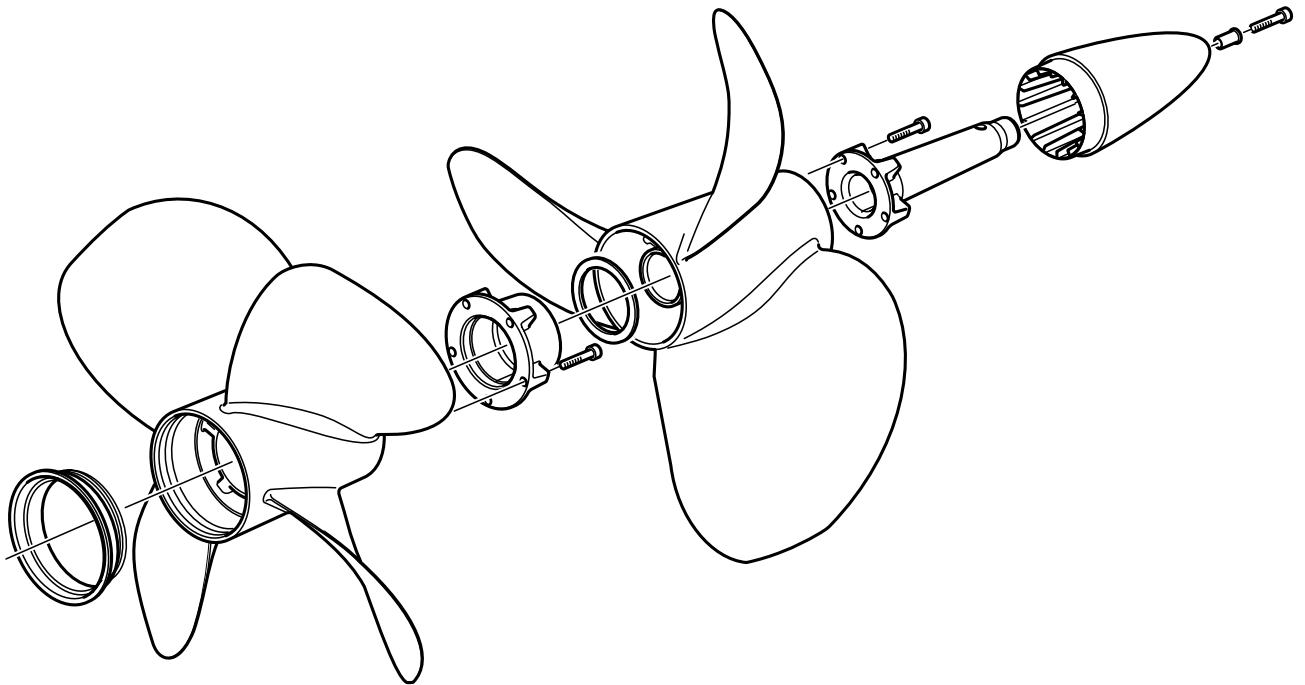





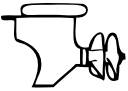

## PROPELLERS FOR VOLVO PENTA IPS DRIVE – TYPE T

The nickel-aluminium-bronze propeller is developed to add to the revolutionary IPS propulsion system's outstanding performance. The design combined with a material that withstands corrosion, as well as minimizing growth, ensure optimum performance and outstanding manoeuvrability.

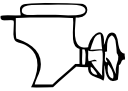





TYPE T DIM				DIM			
T2	3861092	3861093	3861094	T7	3861107	3861108	3861109
T3	3861095	3861096	3861097	T8	3861110	3861111	3861112
T4	3861098	3861099	3861100	T9	3861113	3861114	3861115
T5	3861101	3861102	3861103	T10	3861116	3861117	3861118
T6	3861104	3861105	3861106				

### ACCESSORIES FOR PROPELLERS TO VOLVO PENTA IPS DRIVE – TYPE T

Part No	Qty	Description	Part No	Qty	Description	Part No	Qty	Description
21297787	1	Propeller cone kit	3861209	1	Lock ring	828250	2	Lubricating grease 25g
3886126	1	Propeller cone	3861087	1	Lock nut	21347121	1	Grease, prop shaft 400ml
3861207	1	Propeller nut	3861088	1	Lock plate	3809449	1	Grease 500g
3862454	1	Plastic ring	963699	9	Hex. socket screw			

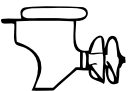

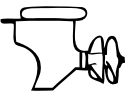
## PROPELLERS FOR VOLVO PENTA IPS DRIVE – TYPE P







TYPE P DIM				DIM			
P1	3843980	3843981	3843982	P5	3843965	3843966	3843967
P2	3843956	3843957	3843958	P6	3843968	3843969	3843970
P3	3843959	3843960	3843961	P7	3843971	3843972	3843973
P4	3843962	3843963	3843964	P8	3843974	3843975	3843989

### ACCESSORIES FOR THE IPS DRIVE – TYPE P

Part No	Qty	Description	Part No	Qty	Description	Part No	Qty	Description
21154200	1	Propeller cone	3593639	1	Felt washer	828250	2	Lubricating grease 25g
	1	Spacer sleeve	21154206	1	Propeller nut	21347121	1	Grease, prop shaft 400ml
3843992	1	Plastic ring	21154277	1	Propeller nut	3809449	1	Grease 500g



## PROPELLERS FOR VOLVO PENTA IPS DRIVE – TYPE Q

TYPE Q DIM				DIM			
Q1	21433621	21433601	21433611	Q5	21433625	21433605	21433615
Q2	21433622	21433602	21433612	Q6	21433626	21433606	21433616
Q3	21433623	21433603	21433613	Q7	21433627	21433607	21433617
Q4	21433624	21433604	21433614				

### ACCESSORIES FOR PROPELLERS TO VOLVO PENTA IPS DRIVE – TYPE Q

Part No	Qty	Description	Part No	Qty	Description	Part No	Qty	Description
40005165	1	Propeller cone	21235219	1	Felt washer	828250	2	Lubricating grease 25g
40005161	1	Propeller nut	963699	11	Hex socket screw	21347121	1	Grease, prop shaft 400ml
40005157	1	Propeller nut	40005165	1	Spinner	3809449	1	Grease 500g



## FOLDING PROPELLERS

Volvo Penta's folding propellers for sail boats combines the folding propeller's low drag under sail with reverse thrust and speed when the engine is used, fully comparable with fixed propellers. A conical toothed section ensures that the propeller blades are in the correct position. With no complicated machinery or mechanisms to cause trouble, the propellers provide superb reliability. The folding propellers are manufactured from a nickel-aluminium-bronze alloy which ensures no growth and excellent corrosion resistance. It is fitted with a bushing at the hub, this absorbs the shock which the propeller and shaft are subjected to during quick shifts forwards and backwards.

The folding propellers are available as Right Hand and Left Hand rotating propellers for both S-drive and shaft installations. The folding propeller's greatest advantage is its low drag under sail. The folding propellers offer outstanding manoeuvrability. Despite being a folding propeller, reverse thrust is fully comparable with that of a fixed propeller.



The 3- and 4-blade propellers offer more or less the same speed as a 3-blade fixed propeller across the full rev range. The huge benefit shows in an increase in sailing speed of up to 1.5 knots due to the low drag. Up to 8 times lower drag compared to a 3-blade fixed propeller. And, what's more, the unique blade profile promotes an extremely quiet and vibration free operation.



## 2-BLADE FOLDING PROPELLER FOR 5-40 HP

The two-blade propeller gives you 20 different blade kits and 6 different hub kits to choose from. Hub and blade are made of a nickel-aluminium-bronze alloy. The blade area is 25 % (2 x 12.5). Available for both sail drive and shaft.



Ø x PITCH		
14 x 7	21629132	21629136
14 x 8	21629140	21629144
15 x 8	21629147	21629152
15 x 10	21629158	21629167
16 x 10	21629173	21629177
16 x 11	21629182	21629186
17 x 11	21629190	21629194
17 x 12	21629198	21629201
18 x 12	21629205	21629211
19 x 13	21629214	21629218

### HUB KITS\* FOR 2-BLADE FOLDING PROPELLER

HUB KIT, S-drive 120/130/S MS25S, 150S 21630720	HUB KIT Shaft 25 mm, Taper 1:10 Key 6 mm 21630721	HUB KIT Shaft 30 mm, Taper 1:10 Key 8 mm 21630722	HUB KIT Shaft 1 1/4" Taper 1:16 Key 5/16 21630724	HUB KIT Shaft 1" Taper 1:16 Key 1/4 21630723	HUB KIT, Pre-drilled, 21630725
Propeller size has to be calculated to match engine and gear ratio. Use calculation program or propeller diagrams.					

\* For a complete propeller, order one blade kit and one hub kit.

## ACCESSORIES 2-BLADE FOLDING

Part No	Qty	Description
3584466	1	Propeller nut
3851994	1	Lock washer
946730	1	Hexagon screw
3888495	2	Shaft
3595221	2	Lock screw
3581246	2	Screw
3858399	1	Zinc anode kit
3858400	1	Magnesium anode kit
963677	3	Hex. socket screw
3888491	1	Anode kit

Part No	Qty	Description
828250	1	Lubricating grease 25g
21347121	1	Grease, propeller shaft 400ml
3809449	1	Grease 500g
3888493	1	Anode kit
963675	2	Hex. socket screw
1161053	1	Locking fluid
873475	1	Tab washer
873473	1	Nut
873474	1	Key

### Drag (N)

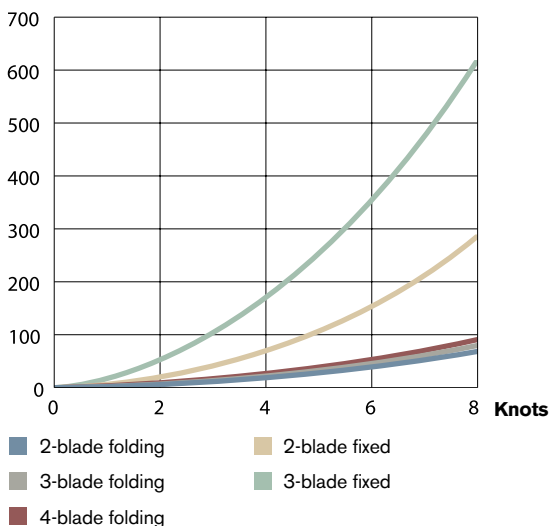



Water drag were measured in a test carried out by SSPA Maritime Consulting. Propellers mounted on S-drives were measured. The lower drag produced by the Volvo Penta folding propellers can boost sailing speed by up to 1.5 knots.

### 3-BLADE FOLDING PROPELLER FOR 25-60 HP

With the three-blade propeller you have 28 different blade kits and 6 different hub kits to choose from. Hub and blade are made of a nickel-aluminium-bronze alloy. The blade area is 37 % (3 x 12.3). Available for both sail drive and shaft.



Ø x PITCH		
14 x 7		3583409
14 x 8		3583410
14 x 9	3583382	3583411
15 x 9	3583283	3583412
15 x 10	3583384	3583413
16 x 10	3583385	3583414
16 x 11	3583386	3583415
17 x 11	3583387	3583416
17 x 12	3583388	3583417
18 x 12	3583389	3583418
18 x 13	3583390	3583419
18 x 14	3583391	3583420
18 x 15	3583392	3583421
18 x 16	3584031	3583422
19 x 16	3583393	3583423

#### HUB KITS\* FOR 3-BLADE FOLDING PROPELLER

HUB KIT, S-drive 110/S, 120/S, MS25S/SR 3858955	HUB KIT Shaft 25 mm, Cone ratio 1:10, Wedge 6 mm, 3583424	HUB KIT Shaft 30 mm, Cone ratio 1:10, Wedge 8 mm, 3583425	HUB KIT Shaft 1", Cone ratio 1:16, Wedge 1/4", 3583426	HUB KIT Shaft 1 1/4", Cone ratio 1:16, Wedge 5/16", 3583427	HUB KIT, Pre-drilled, 3583428
Propeller size has to be calculated to match engine and gear ratio. Use calculation program or propeller diagrams.					

\* For a complete propeller, order one blade kit and one hub kit.

#### ACCESSORIES 3-BLADE FOLDING

Part No	Qty	Description
3584466	1	Propeller nut
5 3851994	1	Lock washer
6 946730	1	Hexagon screw
7 3581243	2	Shaft
8 963695	2	Hex. socket screw
9 3581246	2	Screw
10 3858399	1	Zinc anode kit

Part No	Qty	Description
3858400	1	Magnesium anode kit
11 963677	3	Hex. socket screw
12 1161053	1	Locking fluid 10ml
14 873473	1	Nut
15 873475	1	Tab washer
828250	2	Lubricating grease 25g
21347121	1	Grease, prop shaft 400ml
3809449	1	Grease 500g

#### Drag (N)

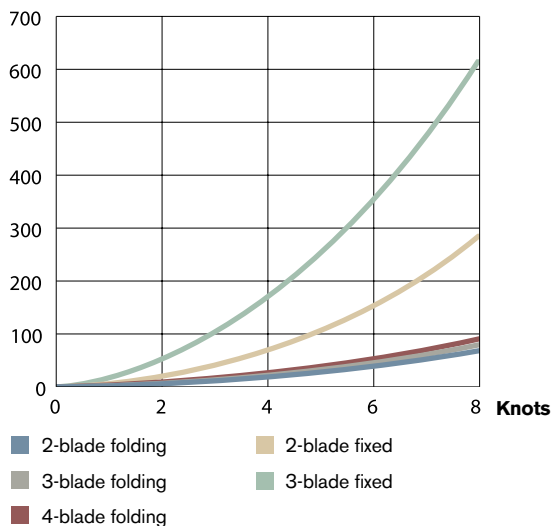



Water drag were measured in a test carried out by SSPA Maritime Consulting. Propellers mounted on S-drives were measured. The lower drag produced by the Volvo Penta folding propellers can boost sailing speed by up to 1.5 knots.

## 4-BLADE FOLDING PROPELLER FOR 55-120 HP

The four-blade propeller provides 10 different blade kits and 7 different hub kits for you to choose from. Hub and blade are made of a nickel-aluminium-bronze alloy. The blade area is 45 % (4 x 11.25). Available for both sail drive and shaft.



Ø x PITCH		
20 x 14	3583917	3583918
21 x 15	3583919	3583920
22 x 16	3583921	3583922
22 x 18	3583923	3583924
22 x 20	3583925	3583926

### HUB KITS\* FOR 4-BLADE FOLDING PROPELLER

HUB KIT, S drive 120/S, MS25S 3583927	HUB KIT, Shaft 25 mm, Taper 1:10, Key 6 mm 3583928	HUB KIT, Shaft 30 mm, Taper 1:10, Key 8 mm 3583929	HUB KIT, Shaft 35 mm, Taper 1:10, Key 10 mm 3583930	HUB KIT, Shaft 40 mm, Taper 1:10, Key 12 mm 3584137	HUB KIT, Shaft 1 1/4", Taper 1:16, Key 5/16 3583931	HUB KIT, Shaft 1 1/2", Taper 1:16, Key 3/8 3583932	HUB KIT, Pre-drilled, 3583933
Propeller size has to be calculated to match engine and gear ratio. Use calculation program or propeller diagrams.							

\* For a complete propeller, order one blade kit and one hub kit.

### ACCESSORIES 4-BLADE FOLDING

Part No	Qty	Description
3584466	1	Propeller nut
5 3851994	1	Lock washer
6 946730	1	Hexagon screw
7 3583951	4	Shaft
8 963695	4	Hex. socket screw
9 3581246	2	Screw
10 3584442	1	Zinc anode kit
3584443	1	Magnesium anode kit
11 963677	3	Hex. socket screw
12 828250	1	Lubricating grease

Part No	Qty	Description
13 1161053	1	Locking fluid
14 873475	1	Tab washer
15 873473	1	Nut
16 873474	1	Key
828250	2	Lubricating grease 25g
21347121	1	Grease, prop shaft 400ml
3809449	1	Grease 500g

#### Drag (N)

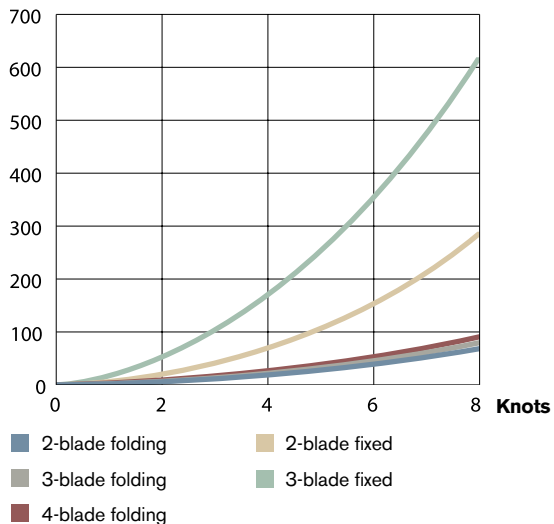

Water drag were measured in a test carried out by SSPA Maritime Consulting. Propellers mounted on S-drives were measured. The lower drag produced by the Volvo Penta folding propellers can boost sailing speed by up to 1.5 knots.

## PROPELLERS FOR S-DRIVE

Volvo Penta's S-drive propellers for 110S and 120S are manufactured of aluminium and bronze alloys, developed to withstand salt water and cavitation damage. The propellers are manufactured to a high and consistent quality under rigid quality controls.

### 2-BLADE

Ø x PITCH	
14 x 7	21351239
14 x 8	21351270
14 x 9	21351241
14 x 11	21351275
15 x 11	21351281
16 x 11	21351235
16 x 13	21351240
17 x 14	21351232
17 x 16	21351265
17 x 17	21353570
19 x 17	21351284



### 3-BLADE

Ø x PITCH	
14 x 9	21381258
14 x 11	21381260
14 x 12	21381262
15 x 12	21381264
15 x 13	21381265
16 x 11	21381283
17 x 12	21381274
17 x 13	21381275
17 x 14	21401615
17 x 15	21381279
17 x 16	21381280
18 x 16	21381042



### S-DRIVES 50S, 100S

	Ø x PITCH	
MB2A	12 x 8	855095
MD5A	14 x 7	851794
MD6A	14 x 8	839514
MB10A, MD11C	16 x 11	839191

## ACCESSORIES FOR S-DRIVE

Part No	Qty	Description
850396	1	Propeller cone kit
851773	1	Screw
850888	1	Plastic washer

Part No	Qty	Description
828250	1	Lubricating grease 25g
21347121	1	Grease, propeller shaft 400ml
3809449	1	Grease 500g





For the right propeller match:  
Use the MPS (Marine Propulsion Software) configuration tool,  
available on [vppn.volvo.com](http://vppn.volvo.com)

**VOLVO  
PENTA**

[www.volvopenta.com](http://www.volvopenta.com)